



N° :

Date : 21 févr. 2018

### Induction motor

4P LS 56M 0,09kW B14 230VD/400VY 50Hz -

**Utilisation :** Environment Current ; Ambiance Non corrosive ; Finition - ; Zone Non specific ; General applications ; Ambient temperature -16 +40 °C ; Maximum altitude 1000 m.

**Motor characteristics :** Aluminium alloy housing ; Aluminium alloy DE endshield ; Aluminium alloy NDE endshield.



### Motor definition

		Application	General applications
Protection type	-	Main voltage (V)	400
Generation code	-	Connection	DY
Efficiency class	-	Motor winding (V)	230VD/400VY
Number of network phases	3	Rated Frequency (Hz)	50
Number of speed	-	Operation position	IM3601(IMB14)
Polarity	4P	Index of protection	IP55
Motor serie	LS	Index of cooling	IC411
Frame size (mm)	56	Insulation class	F
Lenght code	M	Finish	-
HS rated power (kW)	0.090	Moment of inertia J (kg.m <sup>2</sup> )	0.0002500
LS rated power (kW)	-	Motor weight (kg)	4.0
Rated speed (min-1)	1400		
Maximum mechanical speed (min-1)			

### Common definitions

Paint shade	RAL6000
Paint system	la (1 polyurethane coat 20/30 microns)

### Motor mechanical interface

Mounting flange	FT65	Shaft material type	Steel shaft
Drive end shaft type	IEC STANDARD shaft end	Nuance of shaft material	-
Diameter DE shaft (mm)	9j6	Second shaft extension	-
Length DE shaft (mm)	20	Diameter NDE shaft (mm)	-
DE bearing mounting	Locked	Second shaft end length (mm)	-
DE bearing type	DE ball bearing	NDE bearing type	NDE ball bearing
DE bearing	6201	NDE bearing	6201
Code Type de graissage	Vie		

### Motor electrical interface

Connection network type	Terminal box	Cable type	-
Connection network material	Composite materials	Cable gland material	Polyamide cable gland
Connection network position	A	Main cable gland type	1xPE ISO M16
Connection network orientation	up	Principal cable gland position	Right (1)
Connection network relative position	0		

N° :

Date : 21 févr. 2018

Induction motor - 4P LS 56M 0,09kW B14 230VD/400VY 50Hz -

### Motor options

Vibration level	A (25µm ; 1.6mm/s ; 2.5m/s <sup>2</sup> )	Cover	Plastic cover
Balancing type	Half-key (H)	Drip proof cover option	-
Impregnation type	< 95% ; -16+40°C (T)	cooling type	-
Winding thermal protection	-	Forced ventilation characteristics	-
Space heater	-	Encoder type	-
Draining plugs position	6H	Encoder characteristics	-
Nameplate material	Aluminium nameplate	Screw material	Steel screw
Endshield thermal protection	-	Adaptation for vibration sensor	-
Reinforced winding insulation	-		

### Motor characteristics (on mains supply)

Rated speed (min-1)	1400	Unload maximum starting frequency (d/h)	-
Rated current (A)	0.39	Acoustic pressure level (dB(A))	47
No-load current (A)	-	Power factor at 4/4 of the load	0,6
Id / In	3.08	Power factor at 3/4 of the load	0,52
Rated torque (N.m)	0,61	Power factor at 2/4 of the load	0,42
Starting torque (N.m)	1.68	Efficiency at 4/4 (IEC 60 034-2-1) of the load (%)	53.00
Maximum torque (N.m)	1,68	Efficiency at 3/4 (IEC 60 034-2-1) of the load (%)	47.60
Average starting torque (N.m)		Efficiency at 2/4 (IEC 60 034-2-1) of the load (%)	40.80
Rotor locked time (cold) (s)			

N° :

Date : 21 févr. 2018

Induction motor - 4P LS 56M 0,09kW B14 230VD/400VY 50Hz -

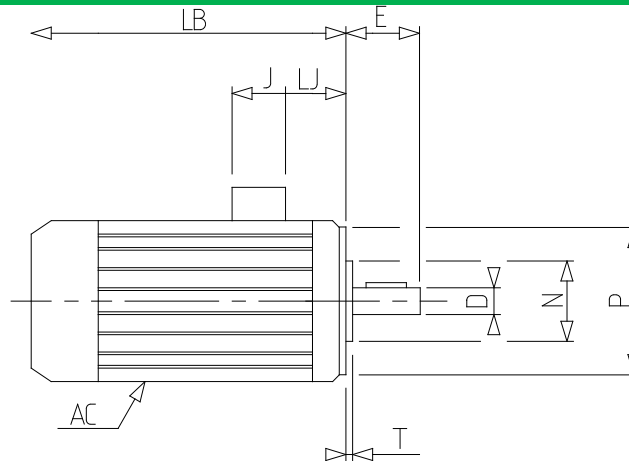
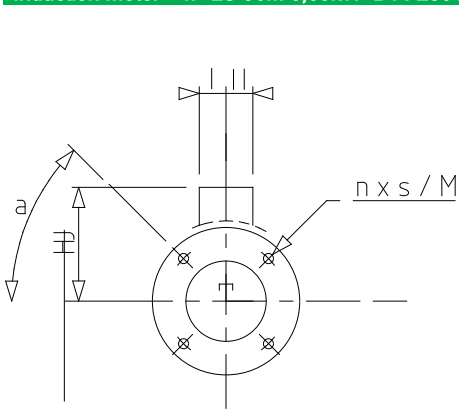

a	45
AC	110.00
D	9j6
E	20
F	3
G	7
GD	3
HJ	85.0
I	40
II	40
J	80
L	16
LA	0
LB	156.0
LJ	17.0
LO	3
M	65
N	50
n	4
O	M4
P	80
p	10
S	M5
T	2.5

